

EMC

Electromagnetic Compatibility



Putting safety first



Contents



	Page
Introduction	3
EMC protection	4
Design, Test and Quality	5
RGS	6-7
RGB	8
RGG	9
Frame Combinations	10
E-RGP för Round Penetrations	11
Components	12
Packing Space	13
Insert Blocks and Spare Blocks	14-15
Installation E-RGS, E-RGB	16
Installation E-RGP	17
Packing Plan	18-19

DISCLAIMER

The author and publisher of this catalogue intend that this catalogue contain only general discussions and information; it is not intended to be comprehensive or to address all the possible contexts and situations involving the products and processes described herein. This catalogue is designed for generic study or research use only and is not a substitute for specific training or experience when utilizing the products and processes discussed herein. Nor is this catalogue intended to serve as a substitute for any proper training and/or certification needed for operation of the products and processes described herein. Accordingly, this catalogue is meant to be advisory and is not intended for specific application. Each application of the products and/or processes described herein may differ and the specifics involved must be addressed separately and individually depending on your situation.

MCT Brattberg (the "Company") assumes no liability for any use of or reliance upon any material contained or referenced in this catalogue; the use of this catalogue is at your own risk. THE COMPANY MAKES NO WARRANTIES, EXPRESS OR IMPLIED, INCLUDING WARRANTIES AS TO MERCHANTABILITY, AS TO THE FITNESS OF THE CATALOGUE OR ITS CONTENTS FOR ANY PARTICULAR USE OR PURPOSE, NON-INFRINGEMENT, OR AS TO THE ACCURACY, APPLICABILITY, OR COMPLETENESS OF THE CONTENTS OF THE CATALOGUE, AND SHALL NOT BE LIABLE FOR ANY LOSS OR DAMAGE, DIRECTLY OR INDIRECTLY, ARISING FROM THE USE OF SUCH CATALOGUE OR FOR CONSEQUENTIAL DAMAGES. In no event shall Company be liable for: (a) punitive, incidental or consequential damages arising out of the use of the information from this catalogue, including, but not limited to, damage to persons or property, loss of use, loss of time, inconvenience, equipment rental, loss of earnings or profits, loss of business opportunities, or any other commercial loss, or (b) any losses, claims, damages, expenses, liabilities or costs (including legal fees) resulting directly or indirectly from use of the material in this CATALOGUE, WHICH IS PROVIDED "AS IS," AND WITHOUT WARRANTIES. The conditions in this paragraph apply to any acts, omissions and negligence of Company that would give rise to a course of legal action. The reader hereby agrees to indemnify and hold harmless Company its officers, directors, shareholders, employees, agents, subsidiaries, affiliates, parent companies and successors in interest against all claims and expenses (including attorney fees) arising from the use of any information in the catalogue. Further, Company is not responsible for any warranties of any nature made by any representative or agent that have not also been agreed to in writing by an officer of the Company.

364 - 388174v1
056390/000001



MCT Brattberg and Lycron are registered trademarks of MCT Brattberg AB, SE-371 92, Karlskrona, Sweden

Production:
Boggi Reklambyrå, Värnamo.

We reserve the right to make changes to our products without prior notice.

MCT Brattberg seals cable and pipe penetrations in potentially hazardous

environments

Cable and Pipe Penetrations exist whenever services are routed through walls, floor, decks or bulkheads. In an emergency situation these penetrations could allow the passage of hazardous such as fire, water and gas.

The unique MCT Brattberg System has been approved by all leading Marine and Civil Authorities as a certified method of sealing such penetrations.

The MCT Brattberg system is a Multipurpose seal designed to allow penetration without compromising the security of the construction. Each and every cable and pipe is lead through a frame by its own pair of halogen free module blocks which are then sealed by the use of a compression system.

The E-MCT seal system in addition to all benefits of the MCT system the specific E-MCT seal system provide protection against electromagnetic pulses, electronic sabotage and static electricity.



Where valuable assets are at risk

For almost half a century MCT Brattbergs' original system for cable and pipe transits has set the standard at sea as well as on land.

The basic idea behind The MCT Brattberg concept is ingeniously simple. It is built around two components: the frame and the insert blocks. The seal is created when the blocks are pressed together in the frame by use of the compression system. It gives a simple and secure installation.

The heart of the system is a rubber material called Lycron, from which the insert blocks are made. It is extremely resistant to fire but MCT Brattberg is much more than a fire and explosion barrier. In addition to extreme heat and enormous pressure changes, the transit withstand smoke, extreme temperature changes, vibrations, sound, damaging insects, chemicals and the effects of ageing.

Necessity for protection

With the growing dependence on computers, communication and control equipment the problem of sensitivity to interference becomes more apparent, given the vulnerability of modern electronic equipment.

The vulnerability can lead to expensive interruptions in production, communication and process control. Consequently, it is essential that two of the most important concerns with modern electronics must be to create a safe and secure environment and to eliminate the risk of interference.

EMC protection from the E-MCT Brattberg systems

Historically, protection of buildings, personnel and equipment from lightning was achieved by the use of lightning conductors. These measures, however, are inadequate as they provide protection from fire and personal injury only; to eliminate the Electromagnetic Interference (EMI), sometimes known as electronic smog, protection must be more specific.

The protection is achieved by a means known as Electromagnetic Compatibility (EMC) giving both external and internal interference protection. The MCT Brattberg system is available in a specific EMC version.

Around and in close proximity to every electrical conductor exist a magnetic field. This magnetic field generates/interferes with the current flow, a feature known as induction. Such induction fields can easily cause important information to be destroyed and, in extreme cases, affect the electronic equipment.

The ability of any cable to intercept such energy depends on how and where it is installed, on its connection to other units and on its construction. The cables screening properties, therefore depend closely on the cable shielding. The cable screen is able to dissipate and absorb magnetic interference fields, therefore protecting its core

conductor. These electromagnetic interference pulses can be discharged from screen to earth. The E-MCT System contains a

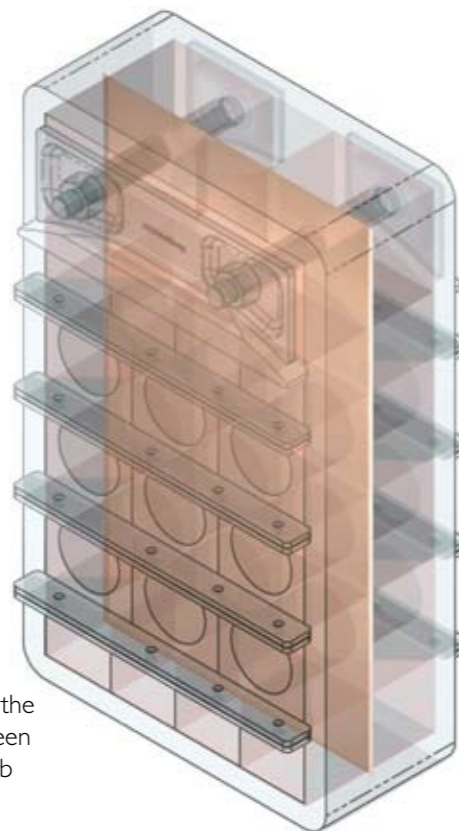

sprung copper sheet which prevents transfer of interference in the cable. Consequently, every E-MCT Transit also works as an extended wall screen.

Benefits of E-MCT Brattberg systems

- Pre-lubricated insert blocks for faster installation with assured continuity.
- Protects against electrical and magnetic interference (EMI), "bugging", electronic sabotage (SEMP) and static electricity (ESD).
- Assists cable management.
- Integral earthing between cables and wall screen.
- Also seals the penetration against the passage of fire, water, gas, sound and environmental hazards.

Design

As with all MCT Brattberg products, the E-MCT Brattberg System comprises of a modular sealing system installed in a frame and sealed by compression system. Uniquely, however, the E-MCT system contains features which ensure earth continuity and screening through the penetration.

Frames are welded into the wall structure to give earth bonding. For round penetrations a steel sleeve is welded to the structure prior to the installation of the RGP transit.

E-MCT module blocks have the facility to screen and earth cables and pipes when installed in such frames.

Stayplates are used to key blocks into frames and aid continuity between module blocks.

The compression plate and E-STG endpacker whilst compressing the system, give the facility to allow full screen and earthing bond.

(Alternatively compression is with the E-PTG Presswedge, see page 12).

The E-MCT blocks consists of 2 different materials:

- The special developed rubber material Lycron is halogen free, prelubricated and gives the advantages of fire resistance, low smoke emission, heat insulation an excellent chemical resistance.
- The integral copper sheet allows the discharging and shielding protection between the cable and the system. In order to achieve continuity

approximately 10 mm of the outer cable insulation must be removed (see photo). The exposed braiding must be placed in the centre of the insert block.

Tested, approved and certified

We have always had and still have the ambition: to be the market's best choice as regards pipe and cable transits.

As early as 1983 our quality system was brought in line with the extreme demands applying to the nuclear power industry.

Today MCT Brattberg is assessed and certified by DNV in accordance with the Quality and Environment Management System standard EN ISO 9001 and 14001, for the design, manufacture and supply of fire barrier and sealed transit systems associated with cable and pipe routes in building and marine environments.

As a direct result of this assessments achievement. Quality are carried out by DNV twice annually.

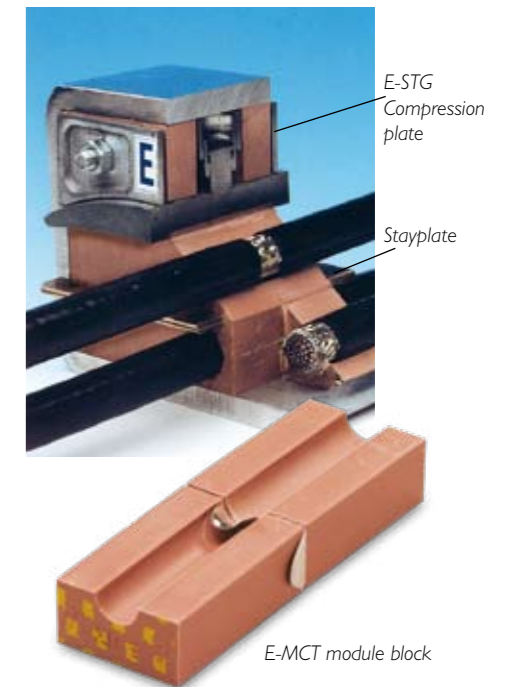

MCT 'Brattberg also holds quality certificates and approvals from a wide variety of classification institutions and customers, among them:

- ABS (American Bureau of Shipping),
- ASC Pty Ltd (Australian Submarine Corp.),
- DNV (Det Norske Veritas),
- Lloyd's Register Quality Assurance,
- US Navy, Framatone ANP,
- Bureau Veritas,
- LPCB BRE Certification Ltd

EMP/EMI tested by:

- FFV (Research Institute for the Swedish National Defence), Sweden
- Karlskrona Shipyard, Sweden
- Saab Avionics AB, Sweden
- IRD Aish & Co Ltd, UK
- LPC HI 20 Firetest, UK
- Siemens AG Research Centre, Germany

RGS

RGSO WITH REMOVABLE END

RGS is MCT Brattberg's standard frame for marine applications. It has a standard internal width of 120 mm and is 60 mm deep. There are four sizes of RGS, denoted by 2, 4, 6 and 8 depending on their height. They may be used in both vertical and/or horizontal multiple frames (see page 10).

The RGS is welded into an accurately pre-cut hole in the deck or bulkhead. As with all our frames, RGS is produced in steel, stainless steel, or aluminium. For installations where cables are already in place, specify RGSO, which has a removable end. RGS weight charts can be found on the next page.



Size in mm								
FRAME SIZE	H (height)	W (width)/Multiple Frames						
		x 1	x 2	x 3	x 4	x 5	x 6	x n
RGS-2	121	140,5	271	401,5	532	662,5	793	W = 10 +
RGS-4	179,5	- " -	- " -	- " -	- " -	- " -	- " -	130,5 x n
RGS-6	238	- " -	- " -	- " -	- " -	- " -	- " -	
RGS-8	296,5	- " -	- " -	- " -	- " -	- " -	- " -	
RGS-2+2	242	- " -	- " -	- " -	- " -	- " -	- " -	
RGS-2+4	300,5	- " -	- " -	- " -	- " -	- " -	- " -	
RGS-2+6	359	- " -	- " -	- " -	- " -	- " -	- " -	
RGS-2+8	417,5	- " -	- " -	- " -	- " -	- " -	- " -	
RGS-4+4	359	- " -	- " -	- " -	- " -	- " -	- " -	
RGS-4+6	417,5	- " -	- " -	- " -	- " -	- " -	- " -	
RGS-4+8	476	- " -	- " -	- " -	- " -	- " -	- " -	
RGS-6+6	476	- " -	- " -	- " -	- " -	- " -	- " -	
RGS-6+8	534,5	- " -	- " -	- " -	- " -	- " -	- " -	
RGS-8+8	593	- " -	- " -	- " -	- " -	- " -	- " -	
RGS-2+2	232	140,5	- " -	- " -	- " -	- " -	- " -	n = number of frames wide. Tolerances single frame: Height ± 1 mm, Width ± 0,8 mm. Material thickness is 10 mm.
RGS-2+4	290,5	- " -	- " -	- " -	- " -	- " -	- " -	
RGS-2+6	349	- " -	- " -	- " -	- " -	- " -	- " -	
RGS-2+8	407,5	- " -	- " -	- " -	- " -	- " -	- " -	
RGS-4+4	349	- " -	- " -	- " -	- " -	- " -	- " -	All measurements are in millimeters.
RGS-4+6	407,5	- " -	- " -	- " -	- " -	- " -	- " -	
RGS-4+8	466	- " -	- " -	- " -	- " -	- " -	- " -	
RGS-6+6	466	- " -	- " -	- " -	- " -	- " -	- " -	
RGS-6+8	524,5	- " -	- " -	- " -	- " -	- " -	- " -	
RGS-8+8	583	- " -	- " -	- " -	- " -	- " -	- " -	

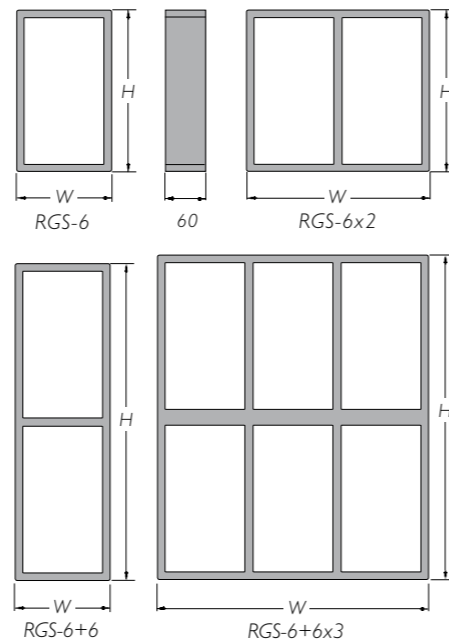

RGS

WEIGHT CHART

Standard frames come in four sizes: 2, 4, 6 and 8. They are all the same width. Height differences are shown below. The material is 10 mm thick.

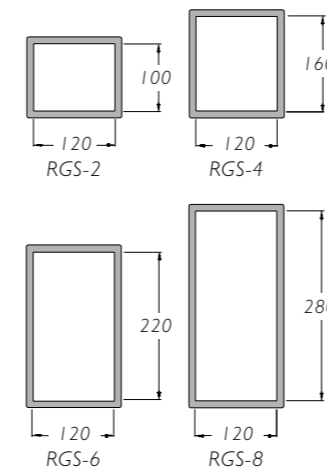

Weight in kilograms								
MATERIAL	FRAME SIZE	W (width)/Multiple Frames						
		x 1	x 2	x 3	x 4	x 5	x 6	
MILD STEEL	RGS-2	2,2	3,9	5,7	7,4	9,2	10,9	
	RGS-4	2,7	4,6	6,5	8,4	10,3	12,2	
	RGS-6	3,2	5,4	7,6	9,8	12,0	14,2	
	RGS-8	3,8	6,3	8,9	11,4	14,0	16,5	
	EN 10025-2	RGS-2+2	3,6	8,1	11,9	15,7	19,5	23,3
	S355JR	RGS-2+4	4,2	8,8	12,8	16,7	20,7	24,6
	1.0045	RGS-2+6	4,8	9,5	13,6	17,8	21,9	26,0
	A36	RGS-2+8	5,5	10,3	14,7	19,1	23,5	27,9
		RGS-4+4	4,8	9,5	13,6	17,8	21,9	26,0
		RGS-4+6	5,5	10,3	14,7	19,1	23,5	27,9
	RGS-4+8	5,9	11,1	15,8	20,5	25,1	29,8	
	RGS-6+6	5,9	11,1	15,8	20,5	25,1	29,8	
	RGS-6+8	6,5	12,0	17,0	22,1	27,1	32,1	
	RGS-8+8	7,2	12,9	18,3	23,7	29,1	34,5	
STAINLESS STEEL	RGS-2	2,2	4,0	5,8	7,6	9,4	11,2	
	RGS-4	2,8	4,7	6,7	8,6	10,6	12,6	
	RGS-6	3,3	5,5	7,8	10,0	12,3	14,5	
	RGS-8	3,9	6,5	9,1	11,7	14,3	16,9	
	EN 10088-2	RGS-2+2	3,7	8,3	12,2	16,1	20,0	23,9
	1.4404	RGS-2+4	4,3	9,0	13,1	17,1	21,2	25,2
	AISI 316L	RGS-2+6	4,9	9,7	14,0	18,2	22,5	26,7
		RGS-2+8	5,6	10,6	15,1	19,6	24,1	28,6
		RGS-4+4	4,9	9,7	14,0	18,2	22,5	26,7
		RGS-4+6	5,6	10,6	15,1	19,6	24,1	28,6
	RGS-4+8	6,0	11,4	16,2	21,0	25,8	30,6	
	RGS-6+6	6,0	11,4	16,2	21,0	25,8	30,6	
	RGS-6+8	6,7	12,3	17,5	22,6	27,8	32,9	
	RGS-8+8	7,4	13,2	18,8	24,3	29,9	35,4	
ALUMINIUM	RGS-2	0,8	1,4	2,0	2,6	3,2	3,8	
	RGS-4	1,0	1,6	2,3	3,0	3,6	4,3	
	RGS-6	1,1	1,9	2,7	3,4	4,2	5,0	
	RGS-8	1,3	2,2	3,1	4,0	4,9	5,8	
	EN 755-2	RGS-2+2	1,3	2,8	4,2	5,5	6,9	8,2
	EN AW-6082	RGS-2+4	1,5	3,1	4,5	5,9	7,2	8,6
		RGS-2+6	1,7	3,3	4,8	6,2	7,7	9,1
		RGS-2+8	1,9	3,6	5,2	6,7	8,3	9,8
		RGS-4+4	1,7	3,3	4,8	6,2	7,7	9,1
		RGS-4+6	1,9	3,6	5,2	6,7	8,3	9,8
	RGS-4+8	2,1	3,9	5,5	7,2	8,8	10,4	
	RGS-6+6	2,1	3,9	5,5	7,2	8,8	10,4	
	RGS-6+8	2,3	4,2	6,0	7,7	9,5	11,2	
	RGS-8+8	2,5	4,5	6,4	8,3	10,2	12,1	

RGB

RGBO WITH REMOVABLE END

RGB is MCT Brattbergs standard frame for embedment or built-in. For EMC protection the frame shall be welded into the wall structure or to a facing place to get eart bounding.

RGB comes in four different sizes, in varying height and designates RGB-2, RGB-4, RGB-6 and RGB-8. The width dimension is always the same, 120 mm, as well as the depth 60 mm.

The frame profiles width are 60 mm and the thickness of the material is 6 mm.

For installations where cables already are in place the RGBO frame with openable gable is used. More information about combination frames can be found on page 10.

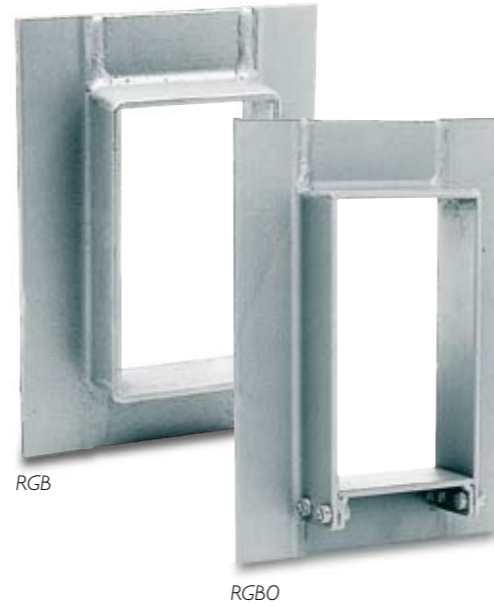

Size in mm								
FRAME SIZE	H (height)	W (width) Combination frames						
		x 1	x 2	x 3	x 4	x 5	x 6	x n
RGB-2	221	240.5	371	501.5	632	762.5	893	W = 110+
RGB-4	279.5	- " -	- " -	- " -	- " -	- " -	- " -	130.5 x n
RGB-6	338	- " -	- " -	- " -	- " -	- " -	- " -	
RGB-8	396.5	- " -	- " -	- " -	- " -	- " -	- " -	
RGB-2+2	332	- " -	- " -	- " -	- " -	- " -	- " -	
RGB-2+4	390.5	- " -	- " -	- " -	- " -	- " -	- " -	
RGB-2+6	449	- " -	- " -	- " -	- " -	- " -	- " -	
RGB-2+8	507.5	- " -	- " -	- " -	- " -	- " -	- " -	
RGB-4+4	449	- " -	- " -	- " -	- " -	- " -	- " -	
RGB-4+6	507.5	- " -	- " -	- " -	- " -	- " -	- " -	
RGB-4+8	566	- " -	- " -	- " -	- " -	- " -	- " -	
RGB-6+6	566	- " -	- " -	- " -	- " -	- " -	- " -	
RGB-6+8	624.5	- " -	- " -	- " -	- " -	- " -	- " -	
RGB-8+8	683	- " -	- " -	- " -	- " -	- " -	- " -	

n = number of frames in width.
Tolerances single frame: 3.5 mm.
Thickness of material 6 mm except for internal horizontal and vertical walls in combination frames such as 10 mm.

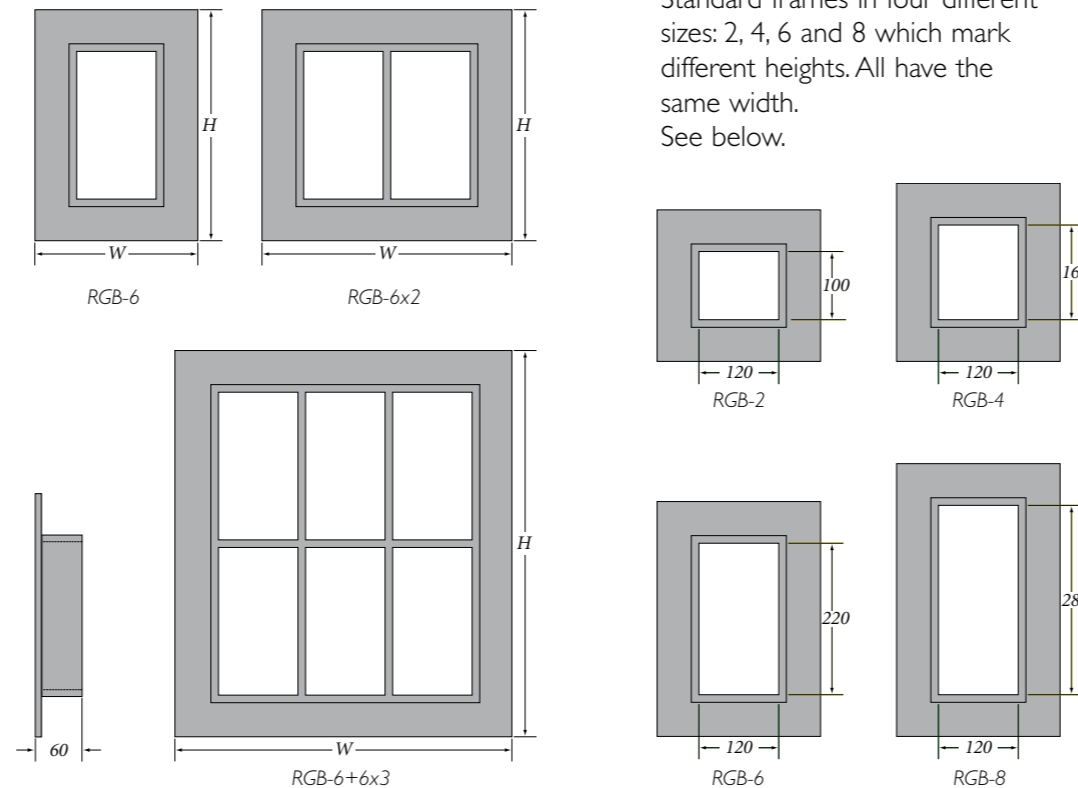

Standard frames in four different sizes: 2, 4, 6 and 8 which mark different heights. All have the same width. See below.

Weight in kilograms								
MATERIAL	FRAME SIZE	W (width) Combination frames						
		x 1	x 2	x 3	x 4	x 5	x 6	
STEEL	RGB-2	3.1	5.0	6.9	8.8	10.7	12.6	
	RGB-4	3.8	5.9	8.1	10.2	12.4	14.6	
	RGB-6	4.4	6.8	9.2	11.5	13.8	16.3	
	RGB-8	5.0	7.7	10.4	13.1	15.8	18.5	
	SS EN 10025-S235JRG2	RGB-2+2	5.0	7.9	10.9	13.9	16.8	19.8
		RGB-2+4	5.6	9.0	12.4	15.7	19.1	22.4
		RGB-2+6	6.2	9.9	13.6	17.3	21.0	24.7
		RGB-2+8	6.9	11.0	15.1	19.2	23.3	27.4
	DIN RST 37-2	RGB-4+4	6.2	9.9	13.6	17.3	21.0	24.7
		RGB-4+6	6.9	11.0	15.1	19.2	23.3	27.4
RGB-4+8		7.4	11.8	16.2	20.6	25.0	29.4	
RGB-6+6		7.4	11.8	16.2	20.6	25.0	29.4	
BS 4360 gr. 40	RGB-6+8	8.1	13.0	17.9	22.7	27.6	32.4	
	RGB-8+8	8.9	14.2	19.5	24.9	30.2	35.5	
NS 17100	RGB-2	3.2	5.1	7.1	9.0	11.0	12.9	
	RGB-4	3.9	6.1	8.3	10.5	12.7	14.9	
	RGB-6	4.5	6.9	9.4	11.8	14.2	16.7	
	RGB-8	5.2	7.9	10.7	13.5	16.2	19.0	
	DIN 1,4404	RGB-2+2	5.1	8.1	11.2	14.2	17.2	20.3
		RGB-2+4	5.8	9.2	12.7	16.1	19.6	23.0
		RGB-2+6	6.3	10.1	13.9	17.8	21.6	25.4
		RGB-2+8	7.1	11.3	15.5	19.7	23.9	28.1
	ASTM/316 L	RGB-4+4	6.3	10.1	13.9	17.8	21.6	25.4
		RGB-4+6	7.1	11.3	15.5	19.7	23.9	28.1
BS 970 gr: 316 S11	RGB-4+8	7.6	12.1	16.6	21.1	25.6	30.1	
	RGB-6+6	7.6	12.1	16.6	21.1	25.6	30.1	
NS 14450	RGB-6+8	8.4	13.3	18.3	23.3	28.3	33.3	
	RGB-8+8	9.1	14.6	20.0	25.5	31.0	36.4	
ALUMINIUM	RGB-2	1.1	1.8	2.5	3.1	3.8	4.4	
	RGB-4	1.4	2.1	2.9	3.6	4.4	5.1	
	RGB-6	1.6	2.4	3.2	4.1	4.9	5.7	
	RGB-8	1.8	2.7	3.7	4.6	5.6	6.5	
	EN AW6082	RGB-2+2	1.8	2.8	3.9	4.9	5.9	7.0
		RGB-2+4	2.0	3.2	4.4	5.5	6.7	7.9
		RGB-2+6	2.2	3.5	4.8	6.1	7.4	8.7
		RGB-2+8	2.4	3.9	5.3	6.7	8.2	9.6
	DIN ALMG SI I	RGB-4+4	2.2	3.5	4.8	6.1	7.4	8.7
		RGB-4+6	2.4	3.9	5.3	6.7	8.2	9.6
	A 6082	RGB-4+8	2.6	4.2	5.7	7.2	8.8	10.3
		RGB-6+6	2.6	4.2	5.7	7.2	8.8	10.3
	BS H30/6082 TF	RGB-6+8	2.9	4.6	6.3	8.0	9.7	11.4
		RGB-8+8	3.2	5.0	6.9	8.7	10.6	12.5
NS 17305								

Multiple Frames



RGS frame



RGB frame

HORIZONTAL MULTIPLE FRAMES

Horizontal multiple frames are described by listing the frame type and size x the desired number of horizontal openings.

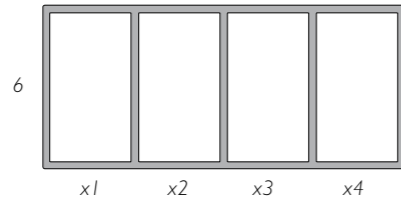

RGS 6x4

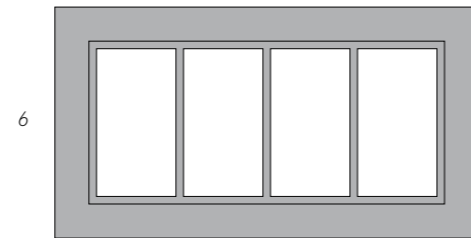

RGB 6x4

Designation:

VERTICAL MULTIPLE FRAMES

Vertical multiple frames are described by listing the bottom frame type and size + the next frame type and size.

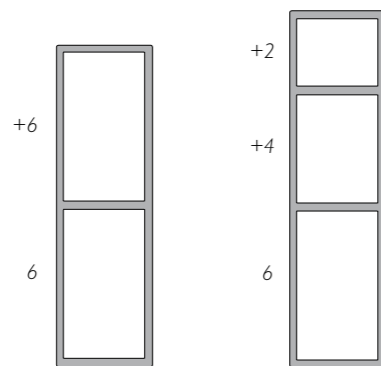

RGS 6+ 6



RGS 6+4+2

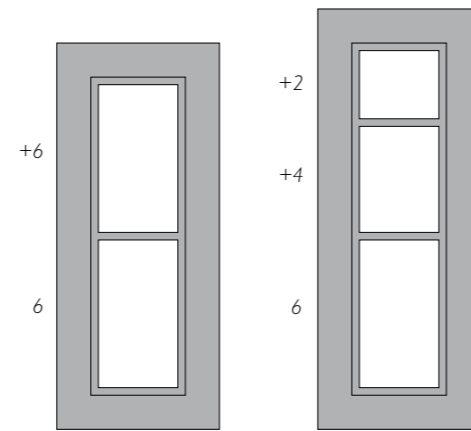

RGB 6+6

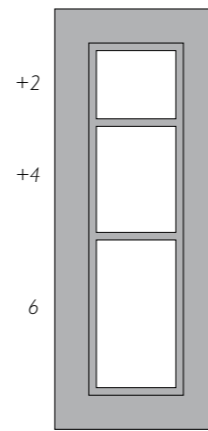

RGB 6+4+2

Designation (starting at bottom):

VERTICAL AND HORIZONTAL MULTIPLE FRAMES

List the entire vertical frames x the desired number of horizontal repetitions.

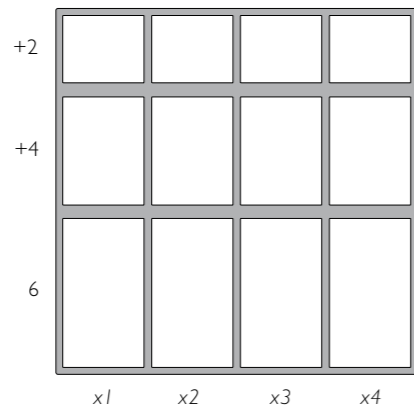

RGS 6+4+2x4

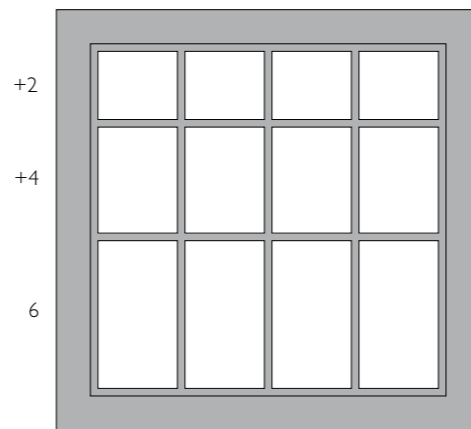

RGB 6+4+2x4

Designation starting at bottom:

NOTE: All multiple frame designations must be preceded by the frame type.

E-RGP-round holes

The E-RGP is a round Lycron frame for assembly in pipes. A copper sheet forms the contact between insert block and pipe housing. The seal is available in 6 sizes with the designations E-RGP -50/L60, -70, -100, -125, -150 and -200.



E-RGP is a circular seal for holes or pipes.

Size in mm		
RGP SIZE	PACKING SPACE	LENGHT AND DIAMETER
E-RGP 50/L60		
E-RGP 70		
E-RGP 100		
E-RGP 125		
E-RGP 150		
E-RGP 200		

Weight in kilograms		
E-RGP 50/L60	E-RGP 70	E-RGP 100
0,25	0,4	0,7
E-RGP 125	E-RGP 150	E-RGP 200
1,0	1,8	3,0

Sleeves

The round sleeve is used to house the E-RGP seal. The sleeve is available in six different sizes. There are several types to choose from, with and without flanges, for welding and for bolting, plus an open version. For more information, contact MCT Brattberg.



Components

STAYPLATE

To be placed between each row of blocks. Stayplates simplify installation, increase stability and anchor blocks within the frame. Plates come in stainless steel.



COMPRESSION PLATE

Usually assembled above the top row of blocks. The plate bolt is tightened to compress blocks around cables, while providing room for E-STG endpacking. Material: Cast iron hot galvanized.



TWEEZERS

Can be used to fit E-insert or spare blocks. Grips the metal sheet and assists installation of the last row of blocks.



Weight in kilograms			
E-STG	E-PTG	COMPRESSION PLATE	STAYPLATE
0,6	0,82	0,63	0,13

E-STG ENDPACKING

Installed between the compression plate and the top of the frame, completing the seal. Made of Lycron with galvanized or stainless steel fittings. The copper sheet forms a contact between the frame and the compression plate.



E-PTG PRESSWEDGE

Can be used as an alternative to the compression plate and E-STG. Can also be placed anywhere in the frame. Made of Lycron, with galvanized or stainless steel fittings. The copper sheet forms a contact between the frame and the stayplate. Must always be installed in combination with a stayplate.



ENDPACKING PULLER



Packing Space

RGS-maximum number of cables and pipes							
FRAME SIZE	BLOCK SIZE						
	15	20	30	40	60	90	120
RGS 2	32	18	8	3	2	-	-
RGS 4	64	36	16	9	4	1	1
RGS 6	96	54	24	12	6	2	1
RGS 8	128	72	32	18	8	2	2

E-RGP-maximum number of cables and pipes							
RGP SIZE	BLOCK SIZE						
	15	20	30	40	60	90	120
E-RGP-50/L60	1	1	-	-	-	-	-
E-RGP-70	4	4	1	1	-	-	-
E-RGP-100	16	9	4	1	1	-	-
E-RGP-125	16	16	4	4	1	-	-
E-RGP-150	36	16	9	4	1	1	-
E-RGP-200	64	36	16	9	4	1	1

Sample packing space plans (RG-Plans) for RGS (below left) and RGP (below right). We recommend placing the larger cables at the bottom.

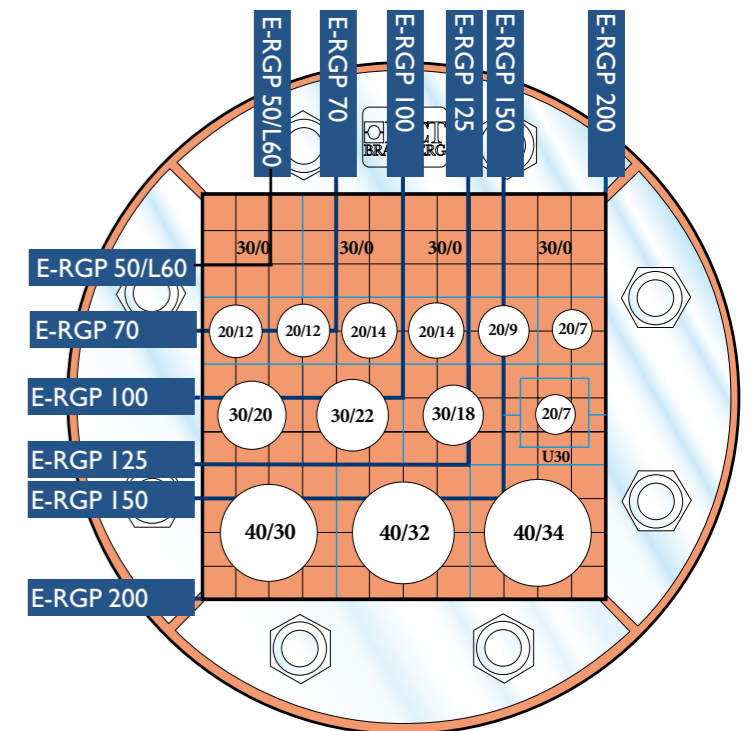
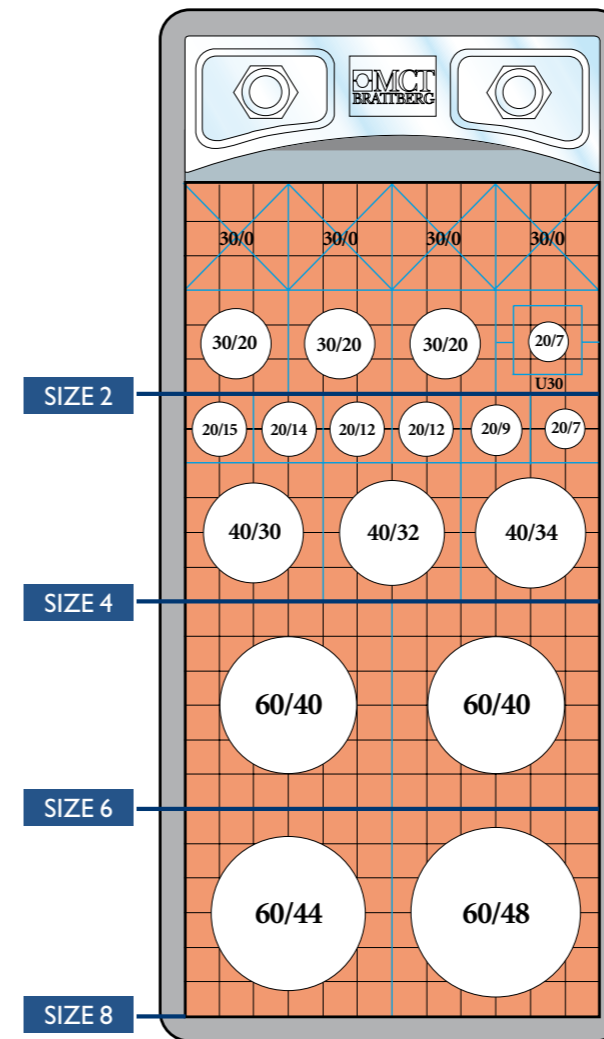

Combination frame width compared with width of cable size						
Cable type	Frame size	Cable tray's width in mm				
		150	200	300	400	600
Signal		6	6 x 2	6 x 3	6 x 4	6 x 5
Power		4	4 x 2	4 x 3	4 x 4	4 x 5
Comb.		6	6 x 2	6 x 3	6 x 4	6 x 5

Choosing the correct E-Insert Blocks

Our standard range of E-blocks accommodates cables between 4 and 54 mm in diameter. It is important that the insert block is the right size, with respect to the cable, to ensure a proper seal.

Measure the cable diameters carefully and choose E-insert blocks accordingly. With the sizing chart on next page you can choose the correct size of E-insert blocks.

E-Blocks are referred to by their width (A) and hole diameter (B). Thus a E-block with a width of 15 mm and a hole diameter of 4 mm is referred to as 15/4. This designation is moulded into the E-block.

The E-MCT block has an integral copper sheet as discharging and shielding protection between the cable and the system.

There are 2 different designs of copper sheets, one for outer cable diameters up to 10 mm and one for outer cable diameters over 10 mm. The design guarantees good contact without damaging the cable braid. In order to correctly install the E-MCT modules they are marked with a yellow E on one of the short ends. The marking also indicates that it is an E-MCT Brattberg System.

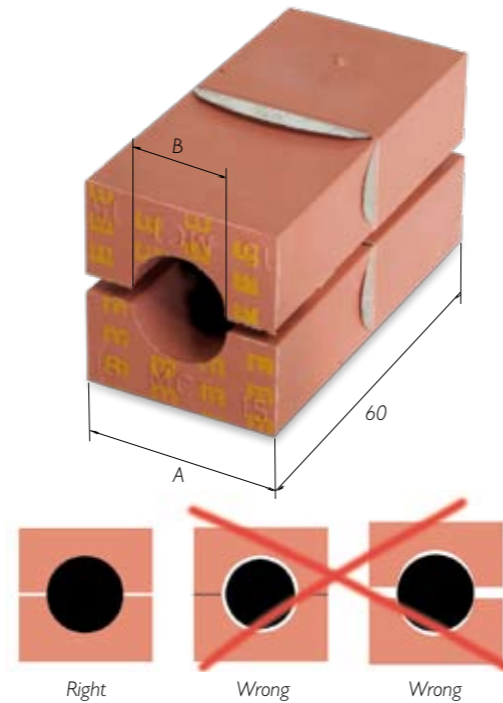

Size in mm													
CABLE DIAM.	A			B	CABLE DIAM.	A			B	CABLE DIAM.	A		B
	15	20	30			30	40	60			60	90	
3.5-4.5	E-15/4	E-20/4		4	21.5-22.5	E-30/22	E-40/22		22	35.5-37.5	E-60/36		36
4.5-5.5	E-15/5	E-20/5		5	22.5-23.5	E-30/23	E-40/22		23	37.5-39.5	E-60/38		38
5.5-6.5	E-15/6	E-20/6		6	23.5-25.5	E-30/24	E-40/24		24	39.5-41.5	E-60/40		40
6.5-7.5	E-15/7	E-20/7		7	25.5-27.5		E-40/26		26	41.5-43.5	E-60/42		42
7.5-8.5	E-15/8	E-20/8		8	27.5-29.5		E-40/28		28	43.5-45.5	E-60/44		44
8.5-9.5	E-15/9	E-20/9		9	29.5-31.5		E-40/30		30	45.5-47.5	E-60/46		46
9.5-10.5		E-20/10		10	31.5-33.5		E-40/32	E-60/32	32	47.5-49.5	E-60/48		48
10.5-11.5		E-20/11		11	33.5-35.5		E-40/34	E-60/34	34	49.5-51.5	E-60/50	90/50	50
11.5-12.5		E-20/12	E-30/12	12						51.5-53.5	E-60/52	90/52	52
12.5-13.5		E-20/13	E-30/13	13						53.5-55.5	E-60/54	90/54	54
13.5-14.5		E-20/14	E-30/14	14						55.5-57.5		90/56	56
14.5-15.5		E-20/15	E-30/15	15						57.5-59.5		90/58	58
15.5-16.5		E-20/16	E-30/16	16						59.5-61.5		90/60	60
16.5-17.5			E-30/17	17						61.5-63.5		90/62	62
17.5-18.5			E-30/18	18						63.5-65.5		90/64	64
18.5-19.5			E-30/19	19						65.5-67.5		90/66	66
19.5-20.5			E-30/20	20						67.5-69.5		90/68	68
20.5-21.5			E-30/21	21						69.5-71.5		90/70	70

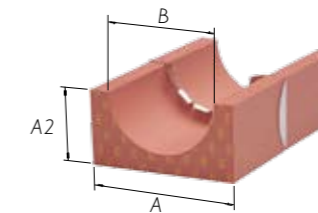

Blocks are referred to by their width (A) and hole diameter (B). Thus a module with a width of 15 mm and a hole diameter of 4 mm is referred to as E 15/4.

Special and larger modules can be made to order.

Spare Blocks

Surplus room in each frame is filled out with solid E-insert blocks. Called spares, they bear the designation A/0.

The copper sheet forms contact between surrounding blocks and the frame.

E-Blocks are referred to by their width (A), followed by the designation /0 (indicating solid). Thus a E-block with a width and height of 15 mm is referred to as 15/0.

The length of E-insert blocks is always 60 mm.

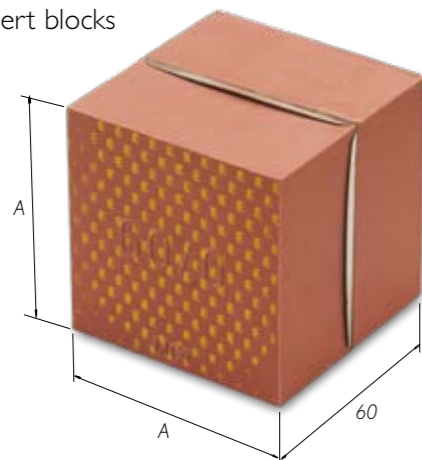

E-BLOCK SIZE Width (A) = Height (A)	E-BLOCK DESIGNATION
5 x 120	E-24 x 5/0
10 x 120	E-12 x 10/0
15 x 15	E-15/0
20 x 20	E-20/0
30 x 30	E-30/0
40 x 40	E-40/0
60 x 60	E-60/0

Weight in grams per half											
E-BLOCK	WEIGHT	E-BLOCK	WEIGHT	E-BLOCK	WEIGHT	E-BLOCK	WEIGHT				
E-24 x 5/0	58	E-20/9	15	E-30/22	24	E-60/48	84				
E-12 x 10/0	113	E-20/10	14	E-30/23	22	E-60/50	77				
E-15/0	20	E-20/11	13	E-30/24	21	E-60/52	59				
E-20/0	38	E-20/12	13	E-40/22	57	E-60/54	61				
E-30/0	84	E-20/13	12	E-40/24	54	E-90/50	287				
E-40/0	150	E-20/14	11	E-40/26	50	E-90/52	279				
E-60/0	338	E-20/15	10	E-40/28	47	E-90/54	273				
E-15/4	10	E-20/16	9	E-40/30	42	E-90/56	262				
E-15/5	10	E-30/12	36	E-40/32	37	E-90/58	255				
E-15/6	10	E-30/13	36	E-40/34	32	E-90/60	243				
E-15/7	10	E-30/14	35	E-60/32	131	E-90/62	239				
E-15/8	9	E-30/15	34	E-60/34	127	E-90/64	229				
E-15/9	8	E-30/16	33	E-60/36	122	E-90/66	220				
E-20/4	18	E-30/17	31	E-60/38	116	E-90/68	211				
E-20/5	18	E-30/18	30	E-60/40	110	E-90/70	204				
E-20/6	17	E-30/19	28	E-60/42	104						
E-20/7	17	E-30/20	27	E-60/44	98						
E-20/8	16	E-30/21	25	E-60/46	91						

Installation E-RGS, E-RGB

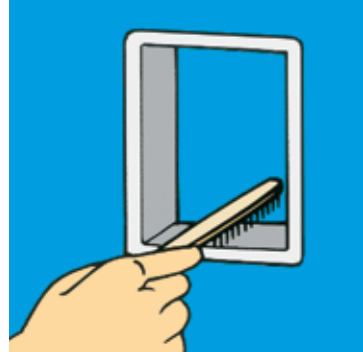

1
Clean the inside of the frame carefully to ensure good electrical contact between the metal sheet and the frame.



2
Pull cables to final position. Mark cable 30 mm from front edge of frame. Remove cable sheath 5 mm on either side of the line.

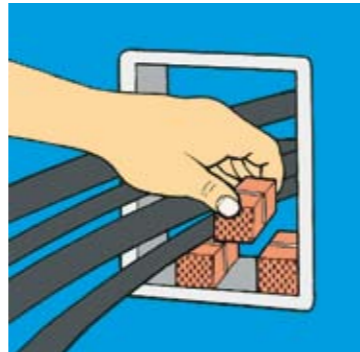

3
When packing the transit, ensure all the insert blocks have "E" marking facing the installet.



4
Position the stayplates between each layer of insert blocks.



5
Before the final row of blocks, the compression plate is installed. Alternatively, the E-PTG Presswedge can be fitted.



6
Tweezers can be used, if required to aid installation of the last row of blocks.



7
Tighten the compression plate bolt until the tongue of the E-STG-1 slides into position around the bolt (32 mm maximum from the inside of the frame to the top of the compression plate).



8
Put the endpacking with the tongue around the bolt. Tighten the nuts in the endpacking until approximately 10-12 mm of free threads are visible.

PRESSURE APPLICATIONS RGS, RGSC, RGSF, RGSK, RGSR AND RGSbtb

Make sure the frame is clean and lubricate the inside of the frame thoroughly. Lubricate all Lycron parts carefully with the MCT Brattberg lubricant.

Place the compression plate in the center so that the rubber can come up between the compression plate and the frame on both sides of the plate.

The seal may not be pressurized within 48 hours of installation. This allows for the settlement of the system (based on a 20°C ambient temperature). NOTE. The lower the temperature, the longer the needed settlement time.

Test pressure 5 bar.

NOTE. For pressurized applications, all components must be replaced with new material after removal and refitting.

Installation E-RGP

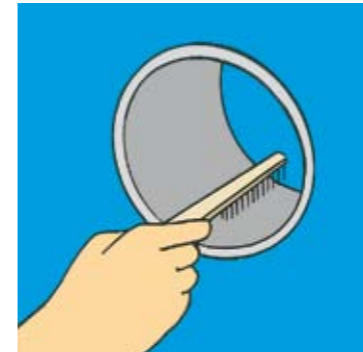

1
Thoroughly clean the inside of the frame. Check that frame dimensions agree with stated tolerances.

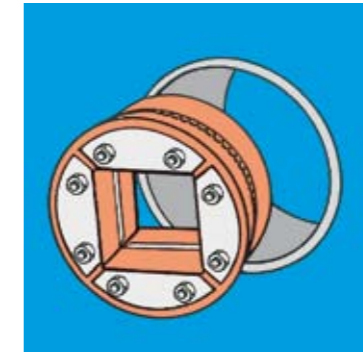

2
Place the E-RGP in the correct position in the opening.



3
Pull the cables to final position. Mark cable 30 mm from front edge of frame. Remove cable sheath 5 mm on either side of the line.

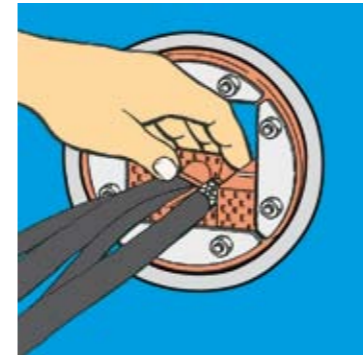

4
When packing the transit, ensure all the insert blocks have "E" markings thread is visible.

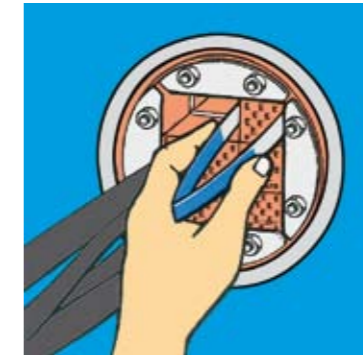

5
Tweezers can be used, if required, to aid installation of last row of blocks.

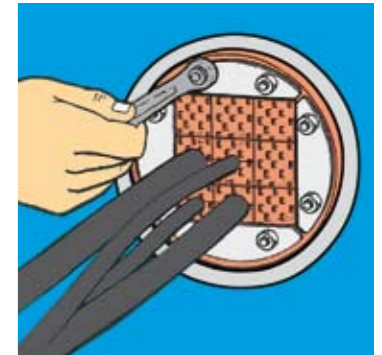

6
Tighten the nuts so that 10-12 mm of the protruding thread is visible.

PRESSURE APPLICATIONS E-RGP

Clean the inside of the pipe and the outside of the E-RGP prior to installation, but apply no lubricant to either surface.

Lubricate all the Lycron parts carefully with the MCT Brattberg lubricant.

The E-RGP seal may not be pressurized within 48 hours of installation - this allows for the settlement of the system (based on a 20°C ambient temperature). NOTE. The lower the temperature, the longer the needed settlement time.

Test pressure 4.5 bar. In the case of higher pressure, please contact MCT Brattberg.

NOTE. For pressurized applications, all components must be replaced after removal and refitting.



www.mctbrattberg.com

MCT Brattberg AB
SE-371 92 Karlskrona
Sweden
Phone: +46-455 37 52 00
Fax: +46-455 37 52 90
E-mail: info@mctbrattberg.se
Website: www.mctbrattberg.se

MCT Brattberg Ltd
Commerce Street
Carrs Industrial Estate Haslingden
Lancashire BB4 5JT
England
Tel: +44 - 170 624 4890
Fax: +44 - 170 624 4891
E-mail: info@mctbrattberg.co.uk

MCT Brattberg Inc.
P.O. Box 374
Spring Tx 77383
USA
Visiting address:
3332 Spring Stuebner Rd
Suite E, Spring TX 77389
Phone: +1 (281) 355 8191
Fax: +1 (281) 355 8393
E-mail: info@brattberginc.com

We have representatives in:

*Austria - Australia - Brazil - Canada - China - Croatia - Denmark - Egypt - Finland - France - Germany - Greece - Hong Kong - Iceland - India
Indonesia - Iran - Ireland - Israel - Italy - Japan - Korea - Malaysia - Netherlands - New Zealand - Norway - Oman - Philippine Islands - Poland - Qatar
Romania - Russia - Singapore - Spain - South Africa - Switzerland - Taiwan - Turkey - Thailand - UAE - Ukraine - United Kingdom - USA*

Visit our website or contact MCT Brattberg for details of your nearest distributor.